

SB26

Advanced Soundbar with Bluetooth® and Powered Subwoofer

Owner's Manual



harman/kardon[®]
by HARMAN

INTRODUCTION	3
DESCRIPTION AND FEATURES	3
SB26 TOP PANEL CONTROLS	4
SB26 REAR PANEL CONTROLS AND CONNECTIONS	5
SB26 SUBWOOFER REAR PANEL CONTROLS	6
REMOTE CONTROL FUNCTIONS	6
PLACING THE SB26	7
PLACING THE SB26 ON A TABLE	7
WALL MOUNTING THE SB26	7
PLACING THE SUBWOOFER	7
CONNECTIONS	8
AUDIO/VIDEO CONNECTIONS	8
POWER CONNECTIONS	8
OPERATION	9
TURNING THE SB26 ON AND OFF	9
TURNING THE SUBWOOFER ON AND OFF	9
PAIRING THE UNITS FOR WIRELESS OPERATION	9
ON-SCREEN INFORMATION DISPLAY (OSD)	9
OPERATING THROUGH BLUETOOTH®	10
SWITCHING SOURCES	10
ADJUSTING THE SYSTEM'S VOLUME	10
SUBWOOFER VOLUME CONTROL	10
MUTING THE SYSTEM	11
SB26 SURROUND MODE BUTTON	11
SUBWOOFER CROSSEVER CONTROL	11
SUBWOOFER PHASE SWITCH	11
PROGRAMMING SB26 TO RESPOND TO YOUR TV REMOTE	12
TROUBLESHOOTING	13
SPECIFICATIONS	14

Introduction

Thank you for purchasing the Harman Kardon® SB26 soundbar, with which you are about to begin many years of listening enjoyment. The SB26 soundbar has been custom-designed to provide excitement and power of the cinema experience in your living room.

To obtain maximum enjoyment from your new soundbar speaker system, we urge you to take a few minutes to read through this manual, which:

- Contains a description of the features of SB26
- Lists the items included in the box
- Describes the SB26 and its components
- Includes step-by-step instructions that will help you set up and get started with the SB26

In addition, a few minutes spent learning the functions of the various controls will allow you to take advantage of all the power and refinement of the SB26 system.

CONTACT US: If you have any questions about SB26, its installation or its operation, please contact your retailer or custom installer, or visit our website at:

www.harmankardon.com

Description and Features

The SB26 is a complete home theater soundbar system that includes:

- Powerful 2-channel amplification soundbar and a 100 W bass reflex wireless subwoofer
- Exclusive Harman Display virtual surround sound
- Simple, one cable HDMI® connection to your TV and two HDMI® inputs
- Wireless Bluetooth® connectivity for streaming from any device
- Compatibility with the Harman Kardon Remote app for easy setup and advanced features
- Wall-mount brackets for the soundbar

The SB26 soundbar contains the system's left and right speakers and stereo amplifiers, and features digital signal processing with Harman Display surround circuitry that creates a complete surround-sound experience without any extra speakers or wires. You can set the soundbar on a table in front of your TV, or mount it on a wall along with your flat-panel TV.

The SB26 subwoofer receives signal from the SB26 soundbar wirelessly, helping you place it anywhere in your room without having to run any wires. It is a 10-inch/250 mm woofer with a built-in 100 Watt amplifier that delivers the full, intended impact and excitement from any movie. Other conveniences include a phase switch for fine-tuning bass performance that suits your listening environment, and an efficient switching system that senses the presence of an audio signal and automatically switches the subwoofer ON.

Harman Kardon invented the high-fidelity stereo receiver more than 50 years ago. With state-of-the-art features and time-honored circuit design, the SB26 leverages this heritage to turn your flat-panel TV into a serious and exciting home cinema.

Included Items

The following accessories are provided with the SB26 soundbar system:

- One soundbar



- One Subwoofer (wireless, 10-inch [250 mm], 100 W)

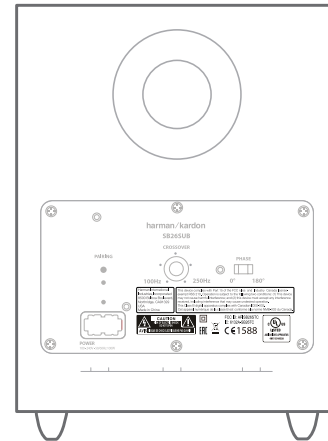

- One set of wall-mount brackets for the soundbar

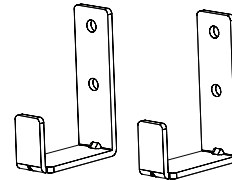

- One power cable for subwoofer

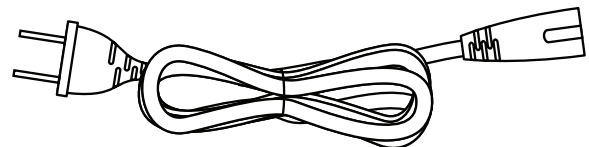

- One remote control

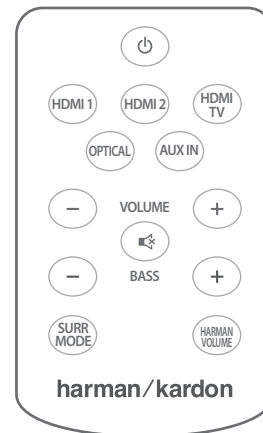

- One IR Repeater cable



- One 24V DC power supply and one AC power cord for the speaker

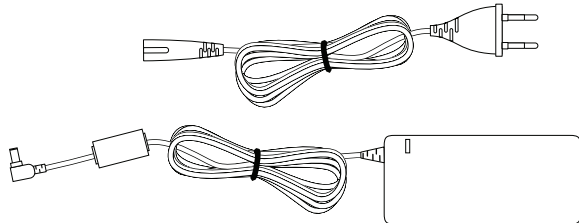

- One HDMI cable

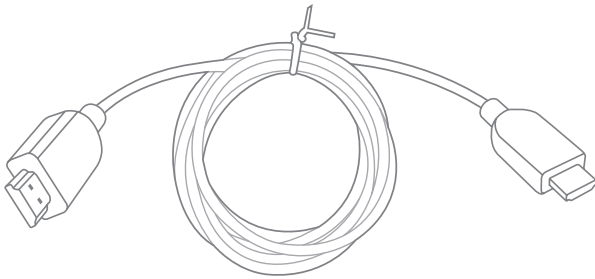

- One 1.5m (5-ft) optical digital audio cable

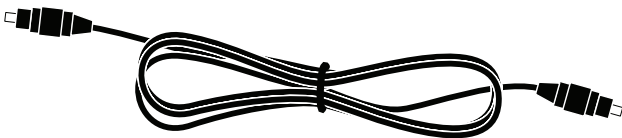

- One 2m (6.5-ft) stereo audio cable

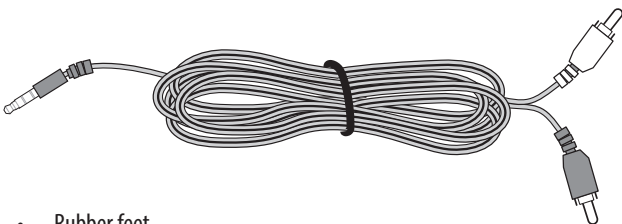

- Rubber feet

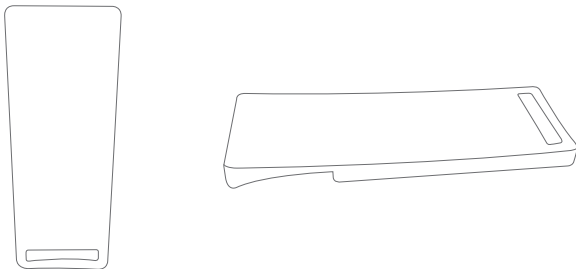

IMPORTANT: If any of these accessories are missing or if any part of your SB26 system fails to operate properly, contact your dealer immediately.

SB26 Top Panel Controls

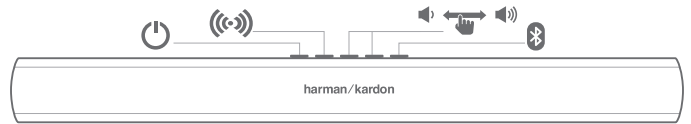

Power Button: The Power button turns the SB26 ON/OFF. When the SB26 is in Standby mode (the power indicator is amber), press this button to turn the system ON (the power indicator turns white).

NOTE: When the SB26 goes automatically to Standby mode, it will automatically turn ON whenever it detects an audio signal at the source inputs. The SB26 will also automatically wake up from the following sources if it would be on those sources before going to Standby.

- Optical audio input
- Analog audio input

For example, if the source input was analog audio when the SB26 went in automatic Standby, it would not wake up if it senses an audio signal from the optical audio input.

When the SB26 system is ON, short press the Power button to put the soundbar in Standby mode (The power indicator turns amber).

Surround Mode Button: The surround mode button turns the SB26 system's Harman Display Surround processing ON and OFF. The surround mode indicator turns amber when Harman Display Surround is active and turns white when Harman Display Surround is not active (normal stereo sound).

Volume Up/Down Buttons: Press the (-) button to reduce the volume, press the (+) button to increase the volume.

NOTE: Pressing both the SB26's Volume buttons at the same time when the system is ON will mute the system. Pressing either Volume buttons while the system is mute will restore the sound.

Bluetooth (BT): The Bluetooth button is used to set the SB26 into Bluetooth mode. You can pair system with Bluetooth-enabled devices using this button.

NOTE: SB26's Bluetooth device name is SB26.

SB26 Rear Panel Controls and Connections

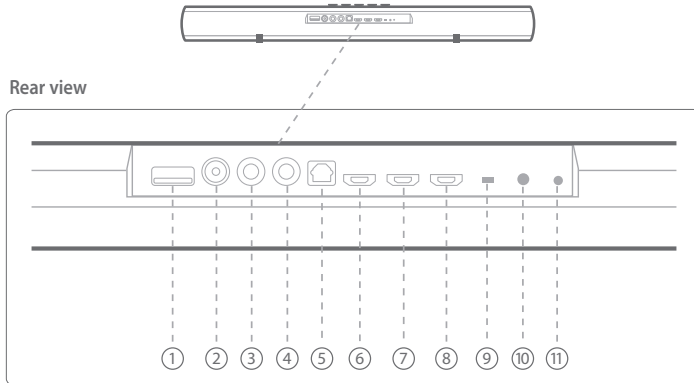

1. USB port (software update only)
2. Power input DC
3. IR transmitter (optional)
4. Aux input (Analog Audio in)
5. Optical (Digital optical Audio in)
6. HDMI TV (To television)
7. HDMI 1 (HDMI input)
8. HDMI 2 (HDMI input)
9. Table /wall equalization switch
10. Wireless subwoofer pairing button
11. Wireless subwoofer pairing indicator

USB Port: The USB port is only for software upgrade. The SB26 allows users to upgrade the software using the HK Remote app from mobile devices. To upgrade the software in the SB26 system, you will require a mobile device with Android or iOS operating system. The software upgrade in SB26 can be performed using the Bluetooth channel to communicate with the mobile device.

Power Input DC: Connect the supplied DC power adapter to this input.

IR Transmitter: Although the SB26 can be wall-mounted, most customers place their soundbar on a TV stand. This can be problematic as it may block the TV's remote control sensor, forcing you to stand up and angle your remote to control your TV. In this case, we recommend you to use the supplied IR Repeater.

To install the IR Repeater:

1. Plug the supplied IR Repeater cable to the back of the SB26.
2. Place the IR Repeater on the back of the SB26 in front of the TV IR Receiver.

The television IR command will automatically transmit from the IR receiver of the SB26

to the IR receiver of the television.

IR repeater installation
(optional)

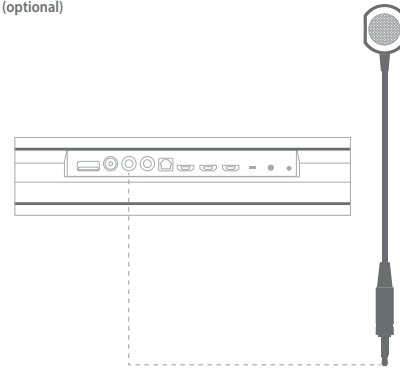

AUX Input: Connect your system to other devices using an AUX cable. You can connect an analog audio device to the SB26 using the 3.5 mm to RCA supplied cable.

Optical: If your TV, disc player or cable/satellite tuner has an optical digital output, use the included optical cable to connect it here.

HDMI TV: Connect your television to this input using the supplied HDMI® cable. If the HDMI input of your television supports Audio Return Channel (ARC) feature, the audio signal from the television will be automatically sent back to the SB26 with this single cable. If your television does not support ARC, you need to have an additional optical or analog cable base on your television compatibility.

HDMI 1 and HDMI 2: HDMI connections transmit digital audio and video signals between the devices. If you have source devices with HDMI connectors, you should use it for the best possible audio and video performance quality.

Table/ Wall Equalization Switch: The table wall switch adjusts the SB26's bass for either wall or table mounting. If you are mounting the SB26 on a wall with the included wall-mount brackets, set this switch to the wall position for the most natural-sounding bass performance. If you are placing the SB26 on a table, set the EQ switch to the table position for the most natural-sounding bass performance.

Wireless Subwoofer Pairing Button: Press the wireless subwoofer pairing button to initiate wireless pairing between the SB26 and the powered wireless subwoofer.

Wireless Subwoofer Pairing Indicator: During a wireless pairing, the subwoofer pairing indicator displays the following:

- Wireless pairing: Blue light blinks with a cycle of 300 ms
- Wireless connection: Blue light constant
- Wireless disconnection: Blue light blinks with a cycle of 1s

SB26 Subwoofer Rear Panel Controls

The following controls are available on the rear panel of the subwoofer:

1. Wireless pairing button
2. Wireless pairing indicator
3. Power input AC
4. Phase adjustment (0 -180°)
5. Continuous crossover adjustment

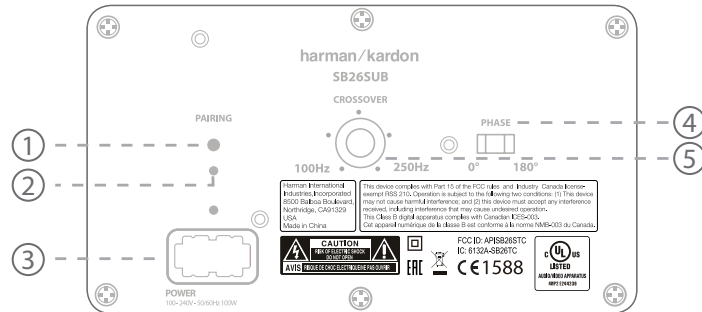

Wireless Pairing Button: Press the wireless subwoofer pairing button to initiate wireless pairing between soundbar and the wireless subwoofer.

Wireless Pairing Indicator: The wireless pairing indicator displays the following:

- Wireless pairing: Blue light blinks with a cycle of 300 ms
- Wireless connection: Blue light constant
- Wireless disconnection: Blue light blinks with a cycle of 1s

Power input AC: Plug your AC power cord here.

Phase Adjustment (0-180°): The phase adjustment switch determines whether the subwoofer driver's piston-like action moves in and out, in phase with the speakers in the SB26. If the subwoofer were to play out of phase with the SB26 speakers, the sound waves from the SB26 could cancel out some of the sound waves from the subwoofers, reducing the bass performance and the sonic impact. This phenomenon is dependent on the placement of the subwoofer and soundbar up to some extent.

Crossover Adjustment: This knob adjusts the subwoofer's crossover between 100 Hz and 250 Hz. The higher you set the crossover knob, the higher in frequency the subwoofer will operate and the more its bass will overlap that of the soundbar. This adjustment helps you achieve a smooth transition of bass frequencies between the subwoofer and the soundbar for a variety of different rooms and subwoofer locations.

Remote Control Functions

The following buttons are available in the remote control:

1. Power
2. HDMI inputs 1, 2 and TV
3. Optical, AUX in
4. Volume control +/-
5. Mute
6. Subwoofer volume control +/-
7. Surround mode, Harman Volume

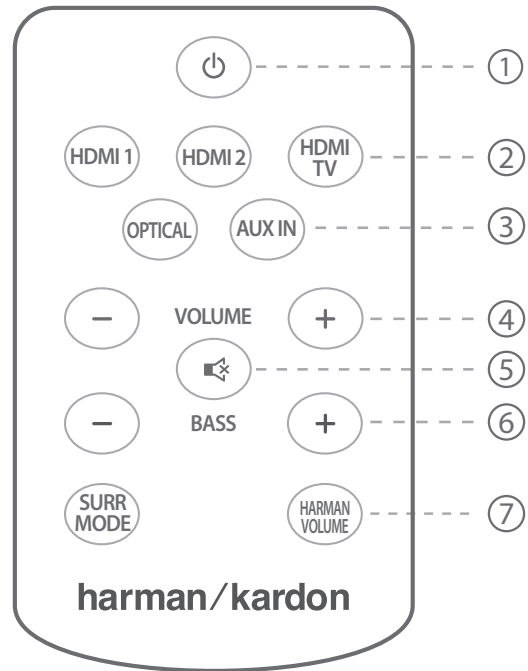

Power Button: To bring the SB26 to operational mode from Standby mode, press the Power button (The Power indicator on the SB26 will turn white).

To put the system in the Standby mode, press the power button while the system is switched ON (The Power indicator on the SB26 will turn amber).

If you do not press the Power button, the SB26 and the subwoofer will automatically go into Standby mode approximately in 10 minutes after the audio input signal stops.

HDMI inputs 1, 2 and HDMI TV: Press a button to activate a source – HDMI 1, HDMI 2 or HDMI TV output for television with ARC support.

Optical, AUX in: Press to select external AUX or Optical inputs.

Volume Control +/-: Press the “+” button to increase volume; press the “-” button to decrease volume.

Mute: Press the Mute button to mute the sound, press the mute button again or any Volume button to unmute.

Subwoofer Volume Control +/-: Use this to control the independent subwoofer's volume. Press “+” to increase the subwoofer's volume. Press “-” to decrease the subwoofer's volume.

Surround Mode: This button turns the SB26's Harman Display Surround processing ON/OFF. The Surround button indicator on the SB26 turns blue when Surround is active, and turns white when Stereo mode is active.

Harman Volume: This button cycles the Harman Volume function between high, low and off. Harman volume is an advanced digital signal processing technology to control playback volume. It evens out the volume level on everything you watch, improving your listening experience. Once you choose the volume level, Harman Volume does the rest. It helps you avoid volume increase from commercials, volume differences when you change channels or switch sources. It helps you listen to the perfect sound effects of the dialogs.

Placing the SB26

Placing the SB26 on a Table

If your TV is placed on a table, you can place the SB26 on the table directly in front of the TV stand, centered with the TV screen.

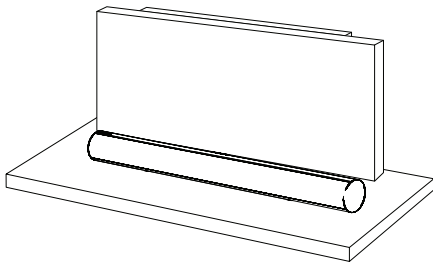

As long as the table's surface is flat, the SB26 will rest on its rubber feet.

Wall Mounting the SB26

If your TV is wall mounted, you can use the included wall-mount brackets to mount the SB26 on the wall directly below the TV screen.

1. Determine the location on wall to place the SB26. Make sure that the top of the SB26 does not block your view of the TV screen when it is mounted on the wall.
2. Mark the locations of the SB26 wall-mount bracket holes on the wall. The holes for the left and right brackets need to be spaced 600 mm apart and are designed to accept #8 screws. The top and bottom holes for each bracket need to be spaced 25 mm apart.



NOTE: To ensure the SB26 to be in level, use a carpenter's level, laser sight or another device to make the two sets of holes exactly at the same height.

3. Attach the two wall-mount brackets to the wall at the locations you marked, using appropriate hardware for the wall's construction and materials. Note that the SB26 weighs 3.6 kg or 8 lbs. Be sure to use hardware that can support this weight.



4. After making all of the connections, attach the SB26 to the brackets by sliding the slots in its feet onto the brackets' vertical tabs.

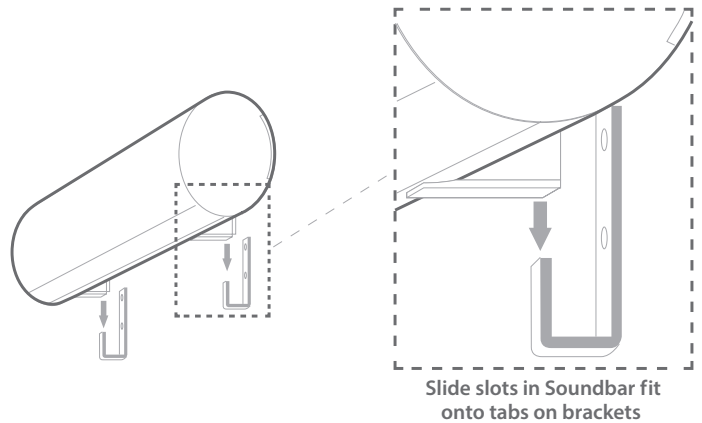

Placing the Subwoofer

The performance of a subwoofer is directly related to its placement in the listening room and its physical position relative to the other speakers in the system. While it is true that our ears do not hear directional sounds at the low frequencies where subwoofers operate. While installing a subwoofer within the limited confines of a room, the reflections, standing waves and absorptions generated within the room will strongly influence the performance of any subwoofer system. As a result, the specific location of the subwoofer in the room becomes important to the amount and quality of bass that is produced.

IMPORTANT: Make sure that the subwoofer's rear panel is at least 150 mm or 6" away from the wall to allow proper operation of its port tube opening.

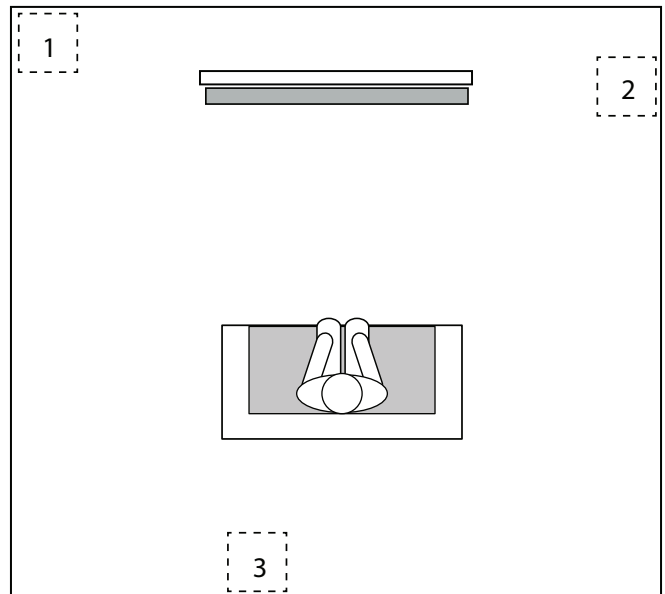

You may place the subwoofer in the positions as represented in the above figure.

- Placing it in a corner that is position (1) will maximize the amount of bass in the room. However, corner placement can also increase the destructive effect of the standing waves on bass performance. This effect can vary depending on the listening position – some listening positions may yield very good results while others may have too much (or too little) bass at certain frequencies.
- Placing the subwoofer along the same plane as the soundbar that is position (2) can produce the best integration between the sound of the subwoofer and the soundbar. In some rooms, the best performance can be resulted by placing the subwoofer behind the listening position (3).

You can experiment with subwoofer placement by temporarily placing the subwoofer in the listening position and playing music with strong bass content. Move it to various locations in the room while the system is playing until you determine where the location of the best bass performance. Place the subwoofer in that location.

IMPORTANT: The maximum wireless operating distance between the soundbar and subwoofer is approximately 15m (50 feet).

Connections

Audio/Video Connections

HDMI ARC TV Out: If your TV has an HDMI input, use the supplied HDMI cable to connect it to the SB26's HDMI ARC TV Out connection. The SB26 will pass video from source devices connected to its HDMI Input connectors; along with its own on-screen display information to the TV. If your TV is equipped with HDMI ARC Function, you can feed its sound to the SB26 via the HDMI ARC TV Out connection, and it will not require additional audio connections to the SB26. The HDMI ARC signal is active when the HDMI TV source is selected.

The HDMI ARC function may require to be activated from your television menu to work. You may refer to your TV owner's manual to activate the HDMI ARC function.

If your television is not equipped with the HDMI ARC option, you will have to connect an optical or analog cable from your television to the soundbar in addition to the HDMI to get the audio.

NOTE: The SB26's On-screen Information Display (OSD) only appears through the HDMI TV Out connector. If you want to see the SB26's OSD, you need to connect its HDMI ARC TV Out connector to your TV even if you are not connecting any HDMI video source devices to the SB26's HDMI In 1/2 connectors.

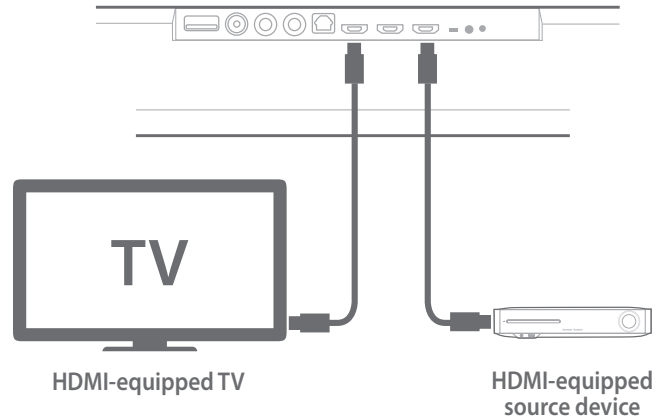

HDMI In 1/2: If any of your source devices have HDMI connectors, connect them to the SB26's HDMI In 1/2 connectors for the best possible video and audio performance quality. Since the HDMI cable carries both digital video and digital audio signals, you do not have to make any additional audio connections for the source devices you want to connect via HDMI connectors.

Aux In and Optical In connections: If your TV and/or source devices do not have HDMI connections, you can use the supplied audio cable and/or optical cable to connect your TV and one source device to the SB26's Aux In and/or Optical In connectors, respectively.

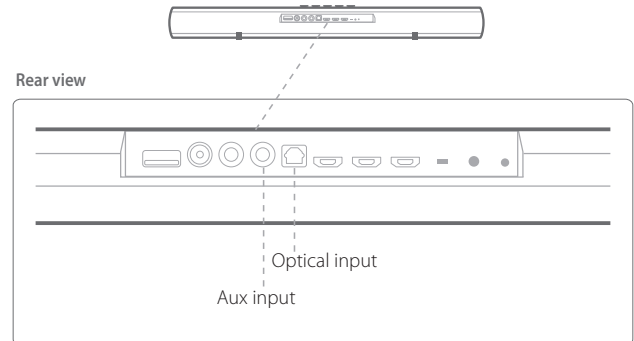

Power Connections

After you have made and verified all of the source connections above:

1. Connect the DC power supply to the SB26's power connection.
2. Plug the supplied AC cord into the DC power supply and into an active, unswitched AC outlet.

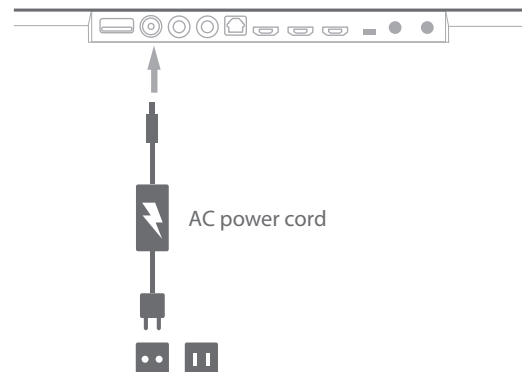

IMPORTANT: DO NOT plug this cord into the accessory outlets found on some audio components.

3. Plug the subwoofer's power cord into an active, unswitched AC outlet.

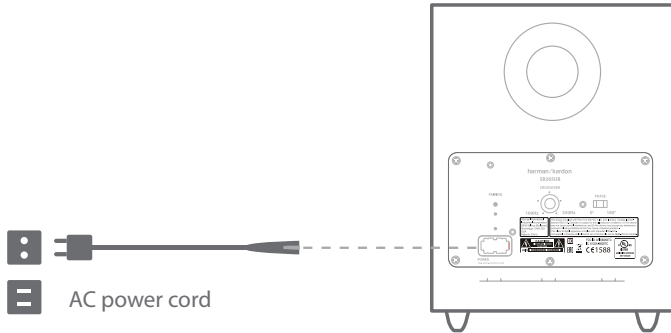

AC power cord

Operation

Turning the SB26 ON and OFF

Manually: To turn on the SB26 manually, short press the SB26's Power button. Press the Power button on either the soundbar or the remote to turn the SB26 ON.

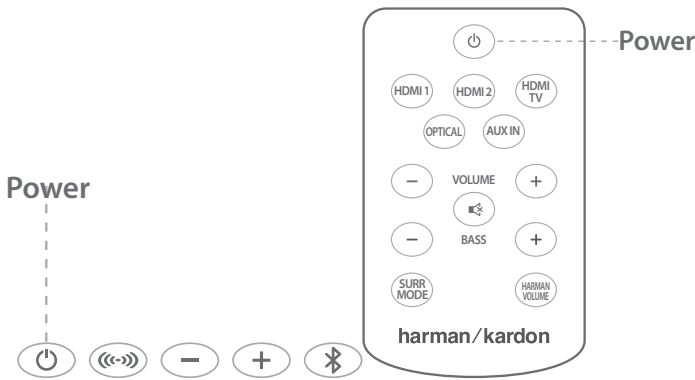

To put the SB26 into Standby manually, short press the Power button.

NOTE: If you put the SB26 into Standby manually, you can turn it ON by manually pressing the Power button again.

Auto turn-on: The SB26 has a signal detector that automatically turns the unit ON when it senses an audio signal on HDMI® inputs using CEC command (compatible product and/or television) or a Bluetooth® streaming. The auto turn-on mode gets activated for analog or optical inputs only when the SB26 goes in auto standby on the audio input from which it senses an audio signal.

Auto turn-off: The SB26 will automatically enter into Standby mode if no audio signal is detected at any of its source input connections for approximately 10 minutes. If you have programmed the SB26 to respond to your TV remote's ON and OFF commands, you can manually put the SB26 into the Standby mode without having to hold its power button for one second.

If you will be away from home for an extended period of time, or if you will not be using the system for an extended period, we recommend you to unplug your system from the AC outlet.

Turning the Subwoofer ON and OFF

The subwoofer will automatically turn itself ON when it senses an audio signal, and it will return to Standby mode when the SB26 goes in Standby mode.

Pairing the Units for Wireless Operation

After turning the soundbar and subwoofer ON for the first time, you will need to pair the subwoofer and soundbar so both of them operate at the same wireless frequency. To pair the units, press the Wireless Pairing switches on both the units one after another within 30 seconds. The units will communicate with each other and operate at the same frequency.

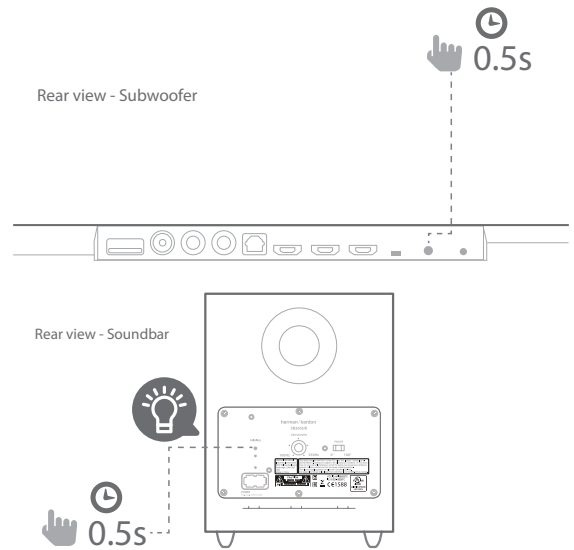

On-screen Information Display (OSD)

The SB26's On-screen Information Display (OSD) will appear on the screen of a TV connected to the HDMI ARC TV Out connector to help you verify the operating status of the SB26. The OSD will overlay on top of the TV's video program for five seconds after pressing a button on the soundbar or remote. (When you select an audio-only source connection such as Aux, Optical, or Bluetooth, the OSD information will overlay a black screen with Harman Kardon logo).

- **Volume control:** When changing the volume of the system, the OSD will display the volume level indication.
- **Subwoofer volume control:** When changing the subwoofer volume, independent from the main volume control, the OSD will display the subwoofer volume level indication.
- **Mute:** When the audio signal is mute, the OSD will display **Mute**.
- **Source:** The OSD will indicate the source input selected.
- **Harman Volume:** The OSD will indicate if the Harman volume is high, low or off.
- **Surround mode:** The OSD will indicate if the Soundbar is in Stereo or Harman Display surround mode.

- **Dolby® Digital:** If a Dolby Digital audio stream is sensed by the soundbar, the OSD will indicate that the Dolby Digital decoding is active.
- **Bluetooth:** The following information is displayed in the OSD during Bluetooth operation:
 - Bluetooth pairing - When the SB26 is in pairing mode
 - Bluetooth connected - When the connection to a new device is successful
 - Bluetooth - When the source Bluetooth is operated

In addition to the status information, the OSD will also display messages if the selected HDMI connection cannot be detected or if the video signal is lost.

Operating through Bluetooth®

To wirelessly stream audio to the SB26 from a Bluetooth-enabled device:

1. Confirm that the SB26 is in the Bluetooth pairing mode (the Bluetooth button LED will be flashing blue). If the LED is not flashing blue, press and hold the Bluetooth button until its LED starts flashing blue. The OSD will display **Bluetooth pairing**.

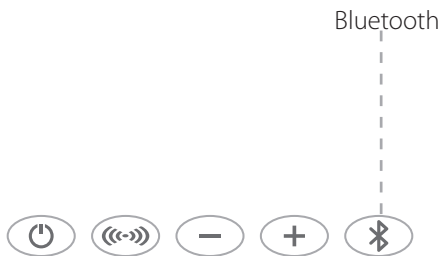

2. Place the device in the pairing mode.
3. Use the device's Bluetooth pairing menu to pair it with the SB26. The system will appear as SB26 in the list of Bluetooth available devices. When the SB26's Bluetooth button LED illuminates constantly, it is paired with the device and you can stream audio via Bluetooth from the device to the SB26. The OSD will display **Bluetooth connected**.

To listen to audio from the Bluetooth device, press the Bluetooth source button on the SB26 to activate the source. If the SB26 is in Standby mode, you can automatically wake up the system by starting to stream an audio Bluetooth signal to the SB26 as long as your device has already been paired with the SB26. The OSD will display **Bluetooth**.

To disconnect the Bluetooth device, press and hold the SB26's Bluetooth button until the LED begins flashing. The OSD will display **Bluetooth pairing**.

NOTE:

- **You can manually switch sources to the paired Bluetooth device by pressing the SB26's Bluetooth button.**
- **If you switch the SB26 to a different source while a paired Bluetooth device is streaming to the system, the SB26 will send a STOP command and the Bluetooth device will stop streaming.**
- **While pairing the Bluetooth device for the first time, it may reset the volume level to maximum.**

Switching Sources

The remote has individual selector buttons for each source except Bluetooth. The active source's Source Indicator LED will illuminate upon selection.

Adjusting the System's Volume

Soundbar

Press the SB26's Volume Up and Down buttons on the remote control or on the soundbar to raise and lower the system's volume, one press at a time. Hold down the button to raise or lower the volume continuously.

NOTE: The lowest setting of the Volume Down button will mute the system.

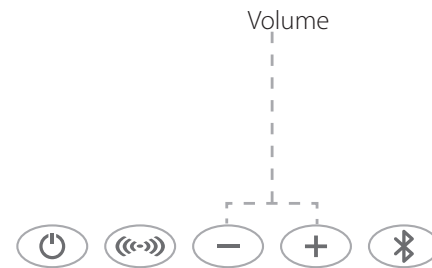

For the best sound, we recommend turning your TV's built-in speakers off. Consult your TV's owner's manual to find out how to do this. If there is no way to turn your TV's speakers off, you can adjust the TV's volume so that your SB26 system will always supply most of the sound:

1. Using the volume buttons on your TV, turn its volume all the way down.
2. Use the SB26's **Volume Up/Down** buttons to set the sound to a comfortable listening level.

This way, your SB26 system should always be louder than your TV speakers.

NOTE: If you play the SB26 at more than 50% of max volume and turn the SB26 off using the Power button, the system will automatically reset at 50% of the max volume.

Subwoofer

Press the remote control subwoofer volume up and down to raise and lower the system's subwoofer volume.

Subwoofer Volume Control

Use the subwoofer's volume control to balance the bass with the rest of the sound. Play music or movies that you are familiar with and adjust the subwoofer's Volume knob so the bass sounds are balanced on both music and films. Listen to several different music recordings and film soundtracks that contain strong bass, and find a setting for the Volume knob that does not over-emphasize the bass or make it sound weak.

Muting the System

To mute the SB26 system:

- Short press SB26's volume "+" and "-" button together (The LED power indicator flashes white).

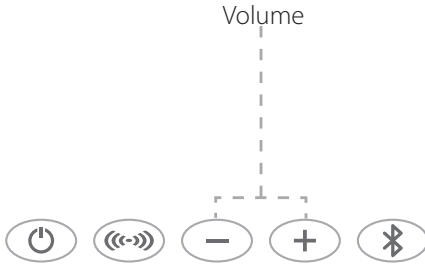

- Press the **Mute** button on the remote control. Press it again to unmute.

SB26 Surround Mode Button

The Surround mode button switches the sound between normal stereo (the surround mode indicator turns white) and Harman Display Surround (the surround mode indicator turns blue). The Harman Display Surround setting will produce a complete surround-sound experience for anyone sitting in front of and several feet away from the soundbar. Although it is effective when watching movies, you can also try the Harman Display Surround setting for music.

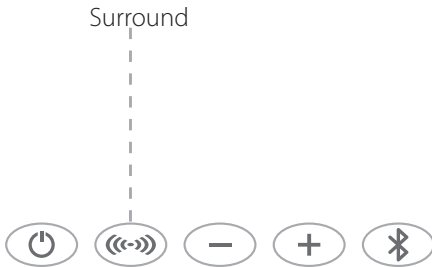

Subwoofer Crossover Control

The subwoofer's Crossover knob adjusts the subwoofer's crossover low pass filter between 100 Hz and 250 Hz. The higher you set the Crossover knob, the higher in frequency the subwoofer will operate and the more its bass will overlap the soundbar. This adjustment helps you achieve a smooth transition of bass frequencies between the subwoofer and the soundbar for a variety of different rooms and subwoofer locations.

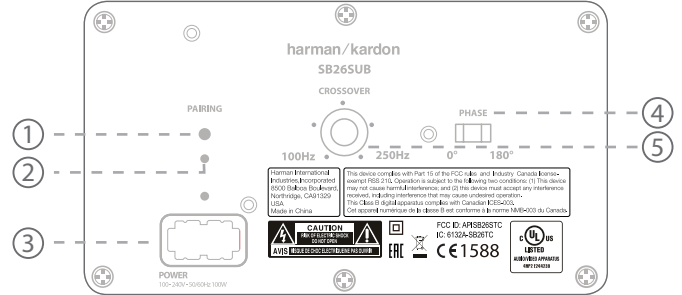

To set the Crossover knob, listen to the smoothness of the bass. If the bass seems to be strong enough at certain frequencies, try a lower Crossover knob setting. If the bass seems to be too weak at certain frequencies, try a higher Crossover knob setting.

Subwoofer Phase Switch

The subwoofer phase switch determines whether the subwoofer's piston-like action moves in and out in phase with the speakers in the soundbar. If the subwoofer were to play out of phase with the Soundbar speakers, some of the sound waves produced by the soundbar and subwoofer could be cancelled out at some frequencies, reducing bass performance and sonic impact. This phenomenon depends in part on the relative placement of all the speakers in the room.

Although there is absolutely no correct setting for the Phase switch, in most cases, it should be left in the 0° position. When the subwoofer is properly in phase with the soundbar speakers, the sound will be clearer and have more impact. This will make percussive sounds like drums, piano and plucked strings sound more lively. The best way to set the Phase switch is to listen to music that you are familiar with and adjust the switch so that drums and other percussive sounds have maximum impact.

Programming SB26 to Respond to Your TV Remote

You can program the SB26 to make it respond to your TV remote's power, mute, volume up and volume down commands. This programming lets you control power and volume functions of your SB26 soundbar with your TV remote. Before beginning to program the SB26, have your TV remote in hand. We recommend sitting down in front of the soundbar.

NOTE: Some steps will time out, so read through this entire process before you begin.

Have the TV remote in hand. When you start programming the remote, be ready to aim the TV remote to the front of the soundbar from about 300 mm – 900 mm (about 12 – 36 inches) away.

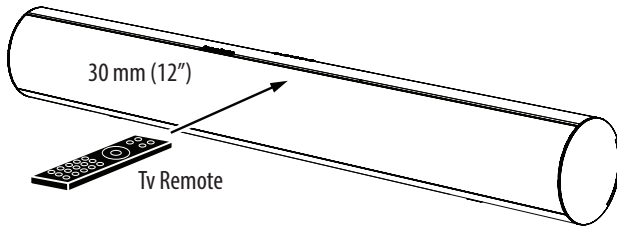

To program the power, surround, volume down, volume up and mute commands:

1. Ensure that the SB26 is ON.
2. On the soundbar, press and hold the soundbar's Surround button until the visible Surround button flashes amber. If the button does not flash after three seconds, release the buttons and try again.

Hold down the button until the surround button indicator flashes



3. You have to press the soundbar button that you want to program (Power, Volume Down, Volume Up, Volume Down and Up simultaneously for Mute).

Momentarily press the button you want to program



4. You have to aim the TV remote at the front of the soundbar and slowly press the corresponding button on the remote until the Surround button on the soundbar flashes white for one second. This indicates that the programming operation has been successful.
5. To exit the learning mode (at any time or when the learning is complete), press and hold the soundbar surround button until the amber illumination stops flashing.

NOTE: If you would like to program a new TV remote control or you are missing a command, restart the whole process.

If you would like to cancel the learning, reset the SB26. Put the SB26 in Standby mode, press and hold the Surround and Volume – button simultaneously. Once factory defaults are restored, the SB26 surround button will flash white for one second, then the unit will enter into operational mode.

Troubleshooting

If your SB26 system does not perform the way you think it should, check whether the problem is covered in this section before contacting your dealer or a Harman/Kardon representative.

Problems	Solutions
If the soundbar does not turn ON	<ul style="list-style-type: none"> Check if the soundbar power supply's AC cord is plugged into a working AC outlet and that the power supply is plugged into the soundbar.
If the subwoofer does not turn ON	<ul style="list-style-type: none"> Check if the subwoofer's power cord is plugged into a working AC outlet. Press the Power switch of the subwoofer. Check if the subwoofer's AC fuse has blown. See Subwoofer Rear Panel Controls.
If there is no sound coming from both the soundbar and the subwoofer	<ul style="list-style-type: none"> Check if soundbar is ON (the Power Indicator should be white). Check if the cable connecting the TV or other source component to soundbar is properly connected at both ends. Check if the soundbar's Source Selector is set to the correct source and that source is playing an audio signal. Check if the system is not muted. If the system is muted, press the volume buttons to un-mute the system. Check if the soundbar's volume is not turned all the way down (the lowest setting of the Volume Down button will mute the system).
If there is no sound coming only from the subwoofer	<ul style="list-style-type: none"> Check if the Subwoofer Volume Control is not turned all the way down using the remote control. Check if the wireless connection is still active (Blue LED constant in the back of the subwoofer). If the LED is flashing blue, then restart the pairing process. Move the subwoofer closer to the soundbar. The maximum wireless operation distance is 50 feet (15.3 m).
If the soundbar's sound is distorted	<ul style="list-style-type: none"> Check the source component to see if the distortion is coming from it, and not from soundbar.
If there is sound from the system, even when the soundbar's volume is turned all the way up	<ul style="list-style-type: none"> If the TV or source component is connected via a variable output, check its instructions if the output is not turned down too low.
If the bass output is not loud enough	<ul style="list-style-type: none"> Turn up the subwoofer's volume using the remote control. Move the subwoofer at a corner of the room. Move the subwoofer closer to the seating location.
The volume is reset when I turn on the soundbar	<ul style="list-style-type: none"> This is actually an inbuilt feature of the soundbar. If the soundbar is playing at more than 50 percent of maximum volume and the power is turned off, the volume of the soundbar is automatically reset to 50 percent of the maximum volume when the system is turned ON.
My TV is ON and my SB26 is in Standby. When I switch off my television, it turns my SB26 ON	<ul style="list-style-type: none"> This is actually related to some issue on some television having wrong Hot Plug Detection (HPD) protocol. You can activate/deactivate HPD protocol by pressing the Volume – and Surround buttons simultaneously.

Specifications

SB26	
Frequency response	38Hz- 28kHz (-6dB)
SB26 CTR Soundbar	
Midrange transducers	Two x 3" (75 mm) cones per channel
High-Frequency transducers	One x 1" (25 mm) dome per channel
Amplifier power	30 Watts x 2
Power requirement	24V DC, 2.7 A
Dimension	110 mm x 920 mm x 89 mm
Weight	3.5 kg
SB26 Subwoofer	
Transducer	10" (250 mm) cone
Enclosure type	Ported
Power requirement	100-240 V AC, 50Hz/60Hz, 100 W
Amplifier power	100 Watts
Dimension	365 mm x 320 mm x 320 mm
Weight	9.4 kg



© 2013 HARMAN International Industries, Incorporated. All rights reserved.

Harman Kardon is a trademark of HARMAN International Industries, Incorporated, registered in the United States and/or other countries. The “beautiful/sound” logo is a trademark of HARMAN International Industries, Incorporated.

The Bluetooth® word mark and logos are registered trademarks owned by Bluetooth SIG, Inc. and any use of such marks by HARMAN International Industries, Incorporated is under license. Other trademarks and trade names are those of their respective owners.

Manufactured under license from Dolby Laboratories. Dolby and the double-D symbol are trademarks of Dolby Laboratories.

The terms HDMI, the HDMI logo, and High-Definition Multimedia Interface are trademarks or registered trademarks of HDMI Licensing LLC in the United States and other countries.

“Made for iPod,” “Made for iPhone,” and “Made for iPad” mean that an electronic accessory has been designed to connect specifically to iPod, iPhone, or iPad, respectively, and has been certified by the developer to meet Apple performance standards. Apple is not responsible for the operation of this device or its compliance with safety and regulatory standards. Please note that the use of this accessory with iPod, iPhone, or iPad may affect wireless performance. iPad, iPhone, iPod, and iPod touch are trademarks of Apple Inc., registered in the U.S. and other countries

harman/kardon
by HARMAN